

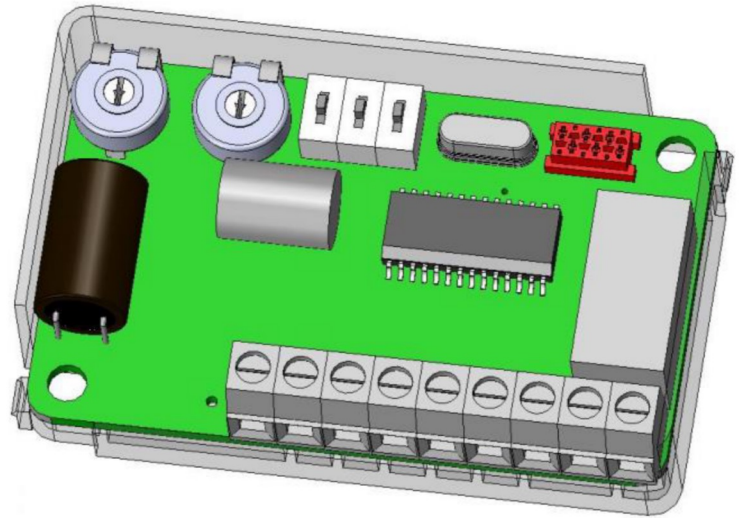

12 - 0110



CARTE RELAIS

RELAY CARD

RELAIS-KARTE

RELAISKAART

TARJETA DE RELÉ



NO
110 VOLTS
220 VOLTS

YES
12 VOLTS
24 VOLTS

-20°C / 60°C

<70%



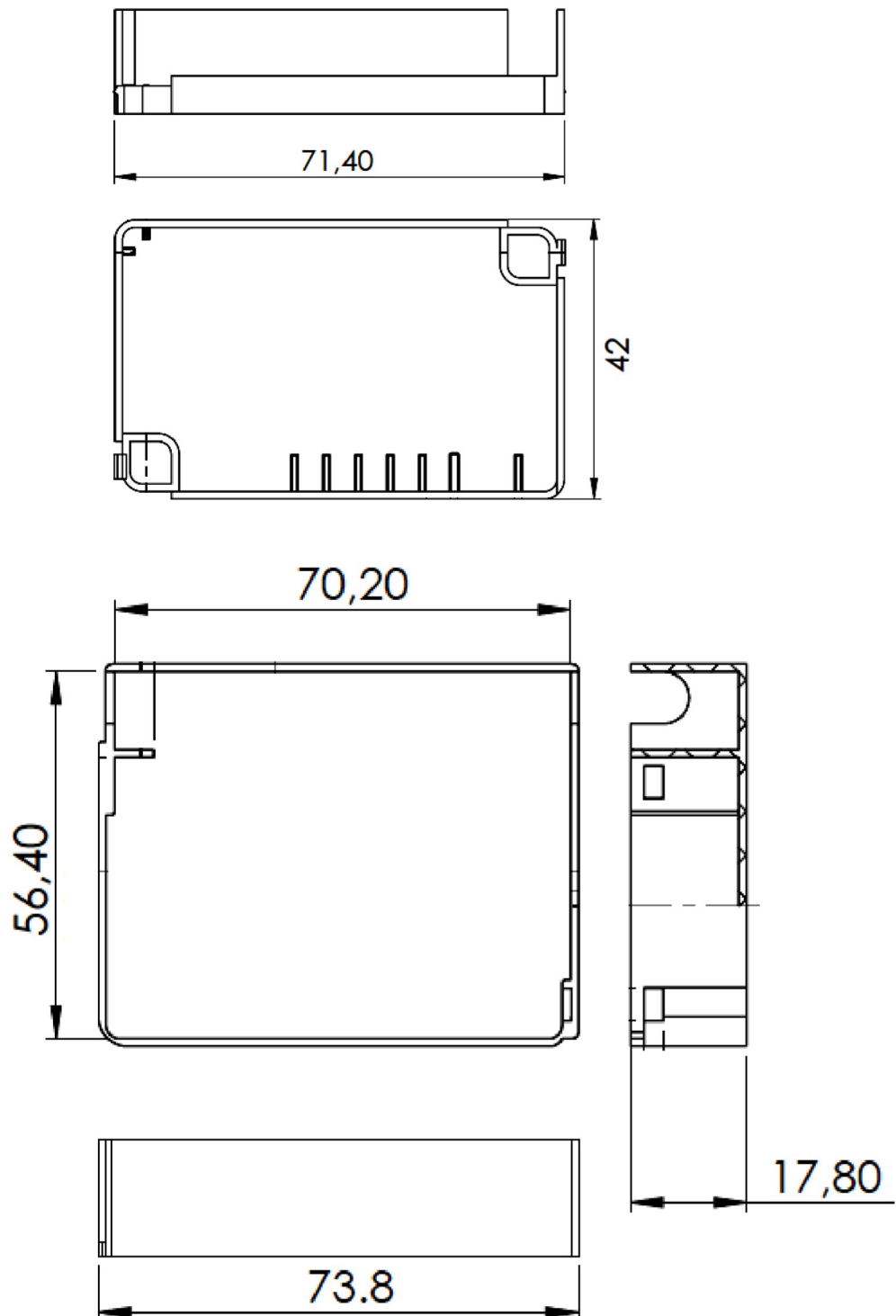
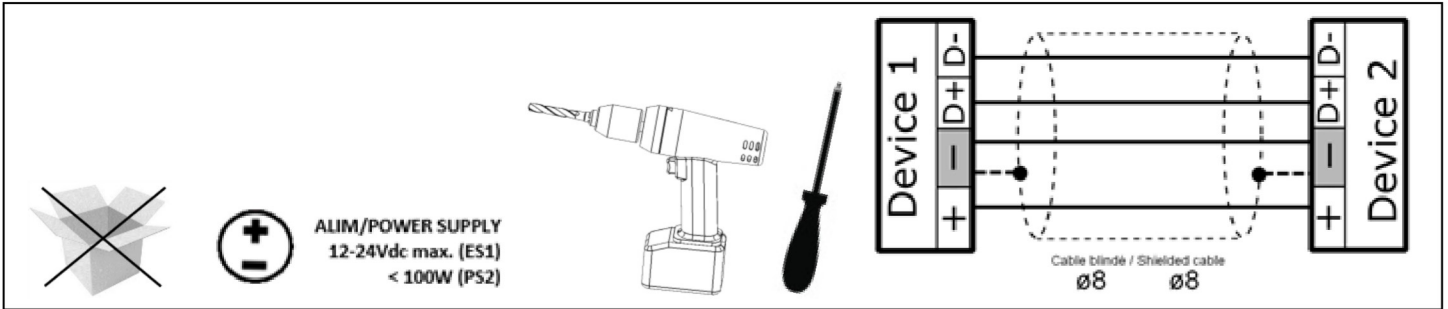
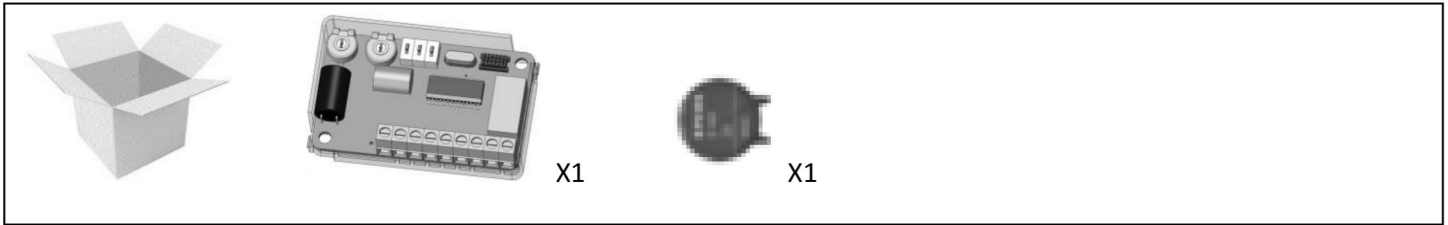

Câblage / Cabling / Verkabelung / Bekabeling / Cableado

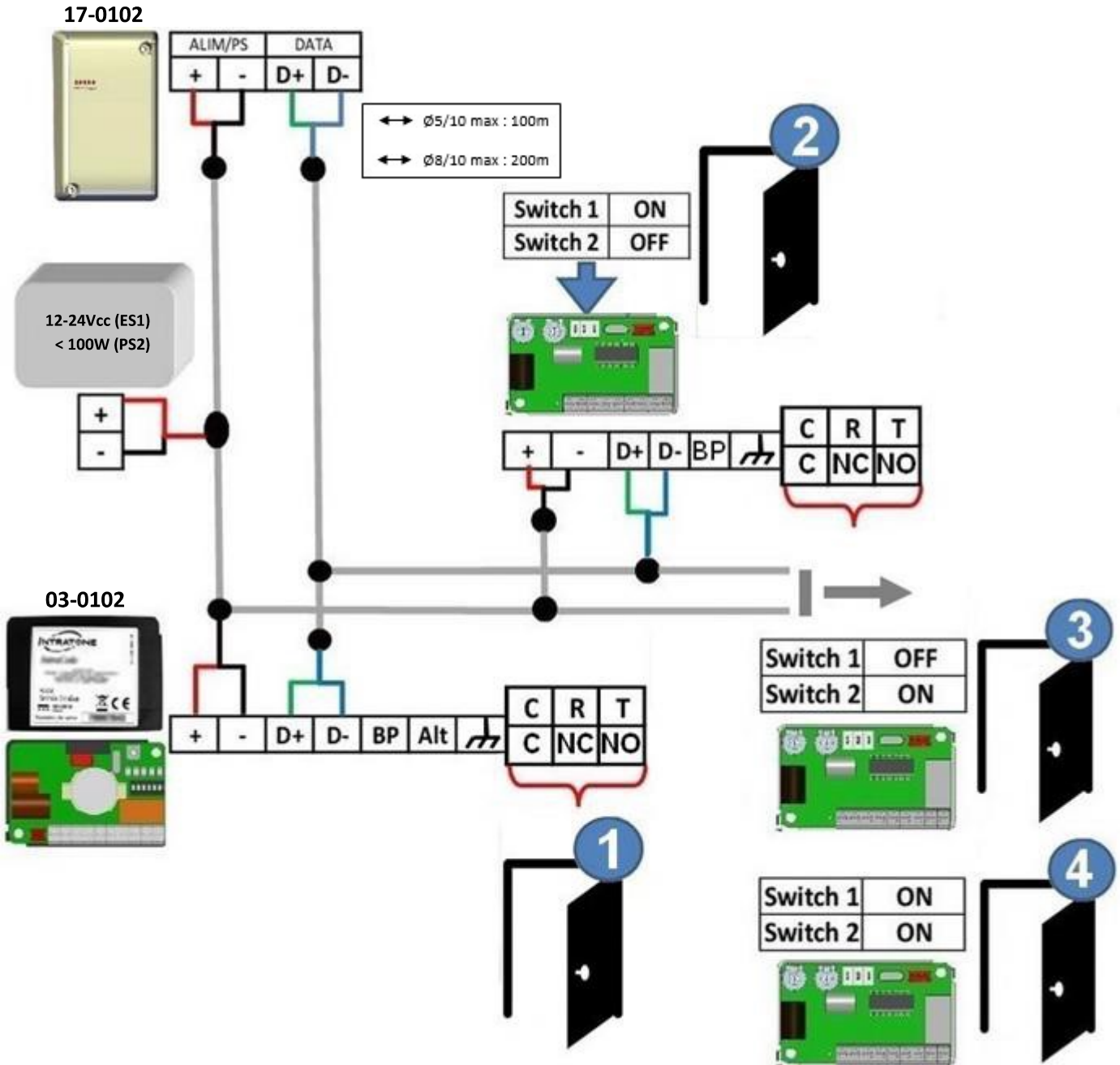

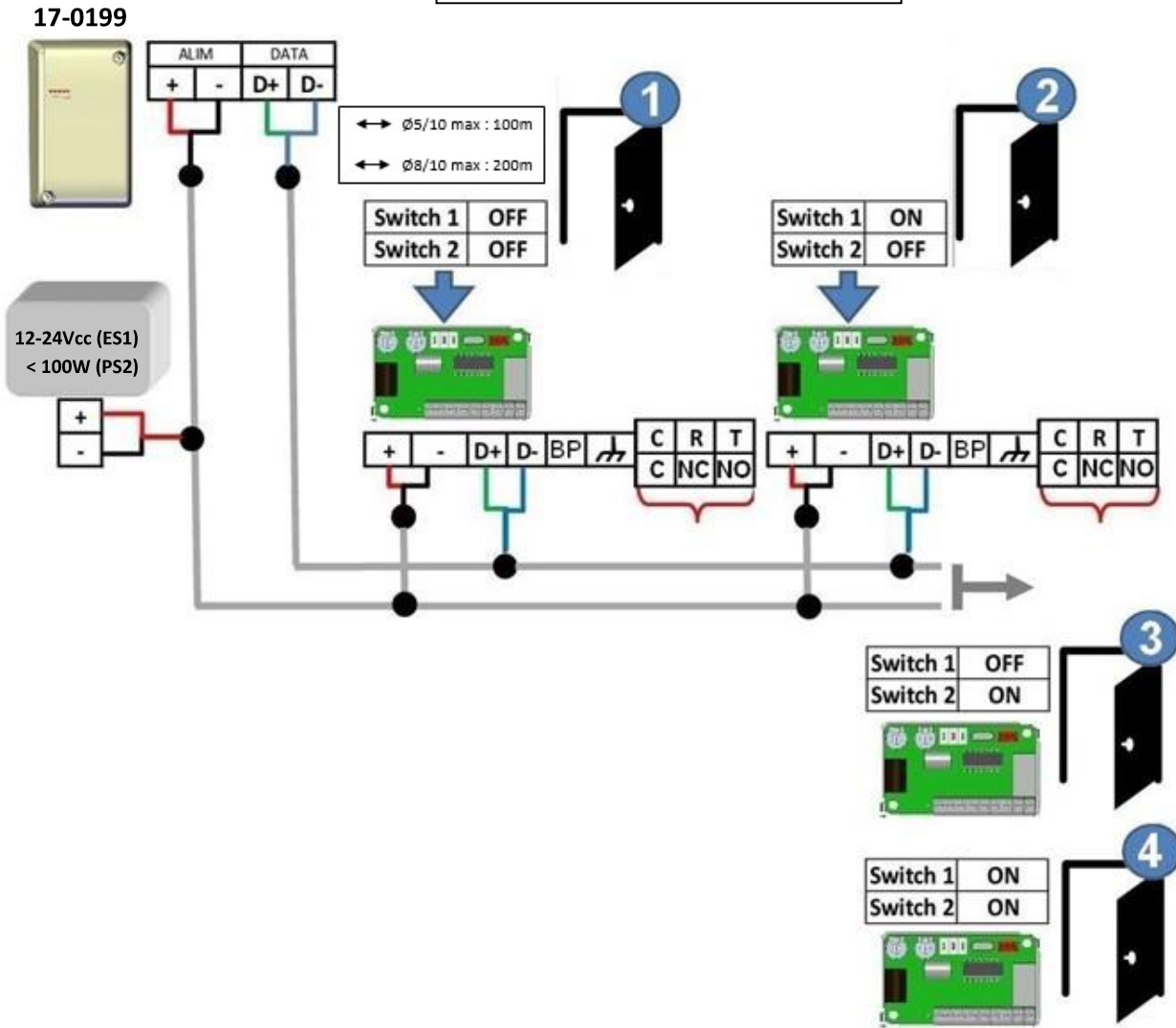

Ref : 17-0199

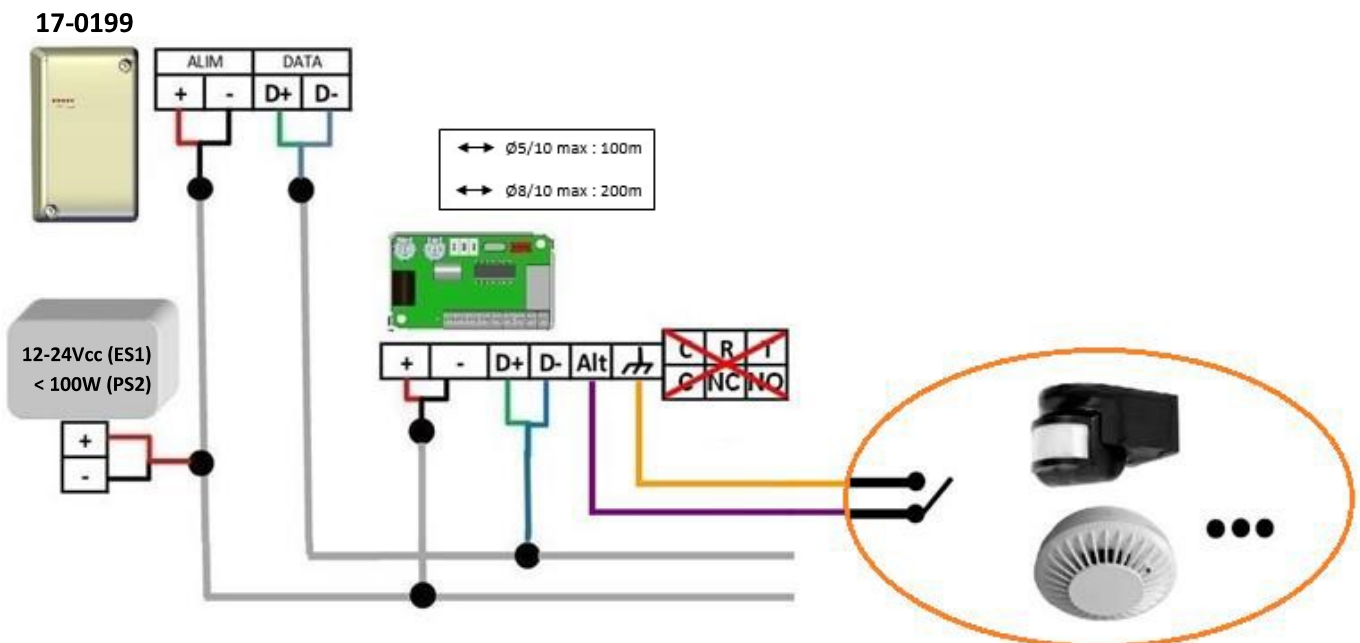

Gérer les alertes / Manage alerts / Alarm-Meldungen verwalten / Beheer meldingen / Administrar las alertas

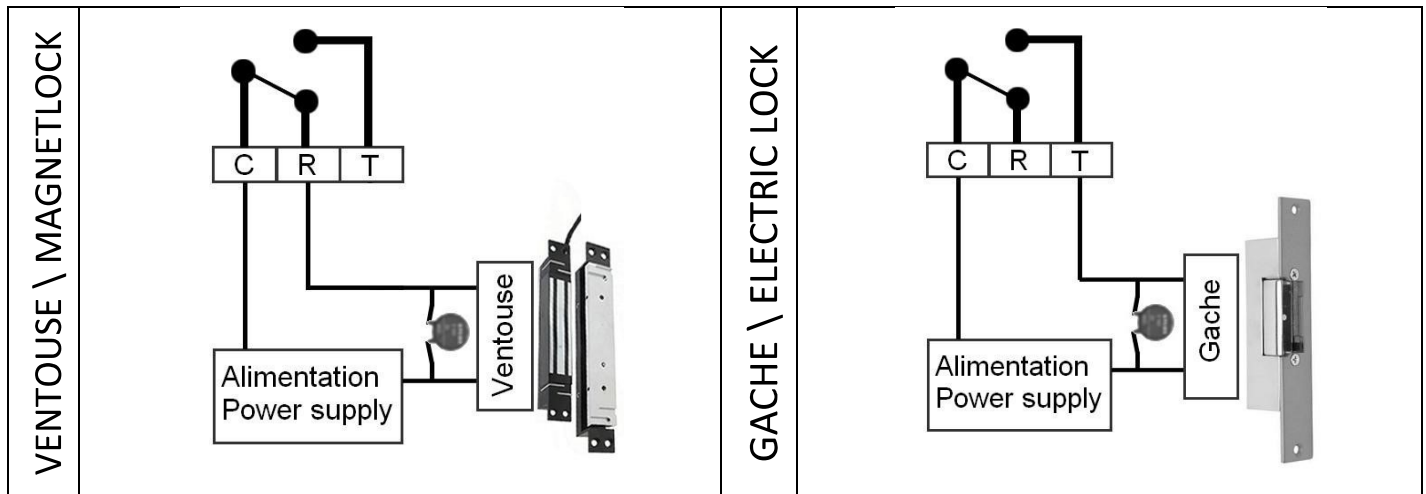





 Obligation sécurité : 

L'accès doit pouvoir être ouvert de l'intérieur en cas de coupure de courant.

Il est nécessaire d'installer une porte équipée d'une barre anti panique, d'un bouton poussoir avec alimentation secourue ou tout système permettant la sortie en cas d'urgence.

 Safety reminder: 

Access must be open from the inside in the event of a power failure.

It is recommended to install a door equipped with an anti-panic bar, a push-button with emergency power supply or any system allowing the exit in case of emergency.

 Sicherheitsverpflichtung : 



Der Zugang muss im Falle eines Stromausfalls von innen geöffnet werden können.

Es ist notwendig, eine Tür zu installieren, die mit einer Anti-Panikstange, einem Druckknopf mit Notstromversorgung oder einem beliebigen System ausgestattet ist, das im Notfall den Ausgang ermöglicht.

 Veiligheidsverplichting: 

De toegang moet van binnenuit kunnen worden geopend in geval van een stroomstoring.

Het is noodzakelijk om een deur te installeren die is uitgerust met een anti-paniekbalk, een drukknop met noodstroomvoorziening of een systeem dat in geval van nood een uitgang mogelijk maakt.

 Obligación de seguridad : 

El acceso debe poder abrirse desde el interior en caso de que se produzca un fallo en la alimentación.

Es necesario instalar una puerta equipada con una barra antipánico, un pulsador con alimentación de emergencia o cualquier sistema que permita la salida en caso de emergencia.

Réglages / Settings / Einstellungen / Instellingen / Ajustes

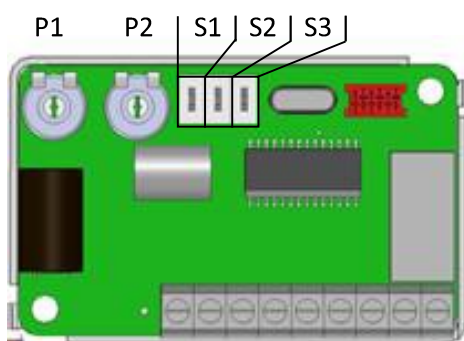

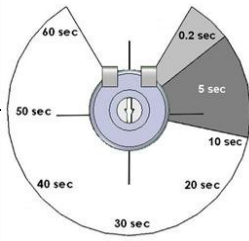
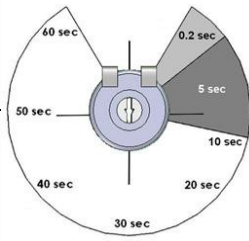
	Réglage du retard entre l'appui et l'ouverture de porte	P1		
	Réglage du temps d'ouverture de la porte	P2		
	Attribution du numéro de porte	N°	S1	S2
		1	OFF	OFF
		2	ON	OFF
		3	OFF	ON
		4	ON	ON

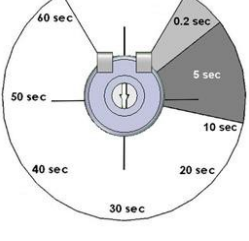
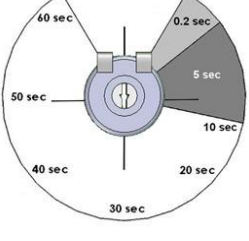
	Set unlock delay	P1		
	Set unlock time	P2		
	Door number allocation	N°	S1	S2
		1	OFF	OFF
		2	ON	OFF
		3	OFF	ON
		4	ON	ON

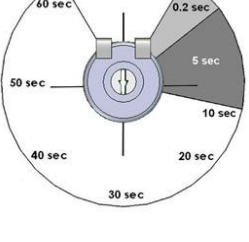
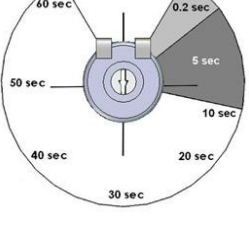
	Entsperrverzögerung einstellen	P1		
	Entsperrzeit einstellen	P2		
	Zuordnung der Türnummer	N°	S1	S2
		1	OFF	OFF
		2	ON	OFF
		3	OFF	ON
		4	ON	ON

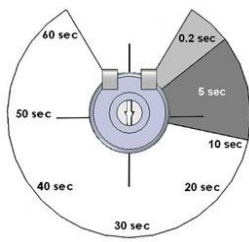
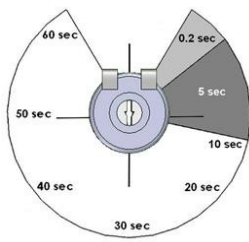
	Ontgrendelingsvertraging instellen	P1		
	Ontgrendelingstijd instellen	P2		
	Toewijzing van het deurnummer	N°	S1	S2
		1	OFF	OFF
		2	ON	OFF
		3	OFF	ON
		4	ON	ON

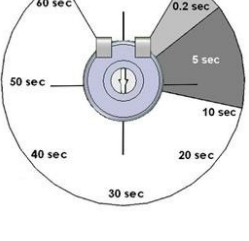
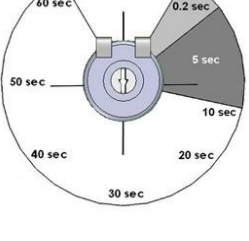
	Ajustar el retardo de desbloqueo	P1		
	Fijar la hora de desbloqueo	P2		
	Asignación del número de puerta	N°	S1	S2
		1	OFF	OFF
		2	ON	OFF
		3	OFF	ON
		4	ON	ON

**Garanties de fonctionnement :**

La Carte Relais 12-0110 est garanti dans une plage de température comprise entre -20°C et +60°C et pour une humidité relative maximum de 70%.

Doit être posé selon le sens Haut / Bas préconisé sur l'appareil.

 Réunir ce point à la Terre, pour des raisons autres que la sécurité.
Ne pas utiliser de fil Vert/Jaune.

**Recyclage du produit en fin de vie :**

La Carte Relais et ses accessoires ne doivent pas être mis au rebut avec les déchets municipaux non triés, mais doivent suivre la filière de collecte et de recyclage des produits DEEE (Déchets d'Equipements Electriques et Electroniques).

**Déclaration de conformité simplifiée**

Le soussigné, COGELEC, déclare que la Carte Relais est conforme à la directive 2014/30/UE (CEM). Le texte complet de la déclaration UE de conformité est disponible à l'adresse internet suivante : <http://certificates.intratone.com/>

Warranty operating guarantees:

The Relay Card is guaranteed within a temperature range of -20°C and +60°C and at a relative humidity level not exceeding 70%.

It must be installed according to the Top/Bottom directions given in these instructions and on the device.

 This point must be earthing, necessary for a purpose other than safety.
Do not used Green/Yellow wire.

**End-of-life recycling of the product:**

The Relay Card and its accessories must not be discarded with unsorted municipal waste, but must be disposed of via the WEEE (Waste Electrical and Electronic Equipment) collection and recycling system.

**Simplified declaration of conformity**

The undersigned, COGELEC, declares that the Relay Card is in compliance with the Electromagnetic Compatibility Regulations 2016. The full text of the declaration of conformity is available at the following internet address:

<http://certificates.intratone.com/>

**Simplified declaration of conformity**

The undersigned, COGELEC, declares that the Relay Card is in compliance with Directive 2014/30/EU (EMC).The full text of the EU declaration of conformity is available at the following internet address:

<http://certificates.intratone.com/>

**Funktionsgarantien:**

Der Relais-Karte ist für eine Temperaturspanne zwischen -20 °C und +60 °C und für eine relative Luftfeuchtigkeit von 70 % gewährleistet.

Muss wie auf dem Gegensprechanlage angegeben in der Richtung Oben/Unten eingebaut werden.

 Um diesen Punkt aus anderen Gründen als der Sicherheit auf die Erde zurückzuholen.
Verwenden Sie keinen grün/gelben Draht.

**Entsorgung des ausgedienten Geräts:**

Das Relais-Karte und sein Zubehör dürfen nicht mit unsortiertem Hausmüll entsorgt werden, sondern müssen an Sammel- und Recycelstellen für Elektro- und Elektronikgeräte-Abfall abgegeben werden.

**Vereinfachte Konformitätserklärung**

Der Unterzeichnete, COGELEC, erklärt, dass die Relais-Karte der Richtlinie 2014/30/EU (EMV) entspricht. Der vollständige Text der EU-Konformitätserklärung ist unter folgender Internetadresse verfügbar:

<http://certificates.intratone.com/>



Werkingsgarantie:

Het Relaiskaart werkt bij temperaturen tussen -20 °C et +60 °C en bij een relatieve vochtigheid van ten hoogste 70%.

Moet gemonteerd worden met de juiste zijden naar boven en onder, zoals aangegeven op het apparaat.



Om dit punt terug te brengen naar de aarde, om andere redenen dan veiligheid.

Gebruik geen groen/gele draad.



Recycling aan het einde van de levensduur:

Het Relaiskaart en zijn toebehoren mogen niet als restafval worden afgevoerd, maar moeten ingeleverd worden bij inzamelpunten voor elektrische of elektronische apparatuur.



Vereenvoudigde verklaring van overeenstemming

Ondergetekende, COGELEC, verklaart dat de Relaiskaart voldoet aan Richtlijn 2014/30/EU (EMC). De volledige tekst van de EU-conformiteitsverklaring is beschikbaar op het volgende internetadres: <http://certificates.intratone.com/>



Garantías de funcionamiento:

El Tarjeta de Relé está garantizado en una franja de temperatura entre los -20 °C y los +60 °C y con una humedad relativa máxima del 70 %.

Debe colocarse con el sentido Arriba / Abajo que se indica en el interfono.



Para traer este punto de vuelta a la Tierra, por razones diferentes a la seguridad.

No use el cable verde/amarillo.



Reciclaje del producto una vez concluida su vida útil:

No deseche el Tarjeta de Relé, ni los accesorios que incluye, junto con los residuos municipales orgánicos. Debe seguir el procedimiento de recogida y reciclaje dispuesto para los productos RAEE (Residuos de dispositivos Eléctricos y Electrónicos).



Declaración simplificada de conformidad

El abajo firmante, COGELEC, declara que la Tarjeta de Relé cumple con la Directiva 2014/30/UE (EMC). El texto completo de la declaración de conformidad de la UE está disponible en siguiente dirección de internet:

<http://certificates.intratone.com/>